













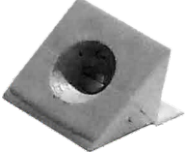







Code	Dimensions			Package	
	Length	Width	Height		
001	1023	420	16	1	1/2
002	798	489	16	1	2/2
003	804	420	16	1	1/2
004	648	489	16	2	2/2
006	654	420	16	1	1/2
007	654	420	16	1	2/2
008	654	398	16	1	2/2
009	528	420	16	1	1/2
010	512	420	16	1	1/2
011	495	378	16	4	2/2
012	1006	419	16	1	1/2
013	1006	146	16	1	1/2
014	420	166	16	1	1/2
015	420	166	16	1	1/2
016	822	508	3	1	2/2
017	663	512	3	1	2/2
018	663	507	3	1	2/2
Accessories				1	1/2

Accessories:

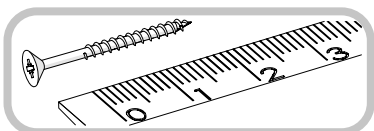
<p>6x a311.60.919</p> 	<p>6x b218</p> 	<p>16x d1 Ø5x16</p> 	<p>22x f1 Ø8x30</p> 
<p>1x f3</p> 	<p>10x l2</p> 	<p>6x k311.054</p> 	<p>3x m30.1</p> 
<p>1x n14</p> 	<p>2x n260.01</p> 	<p>1x p17 Ø6x50</p> 	<p>56x p25 Ø3.5x16</p> 
<p>22x r1 15x12</p> 	<p>6x r10 Ø7x34</p> 	<p>10x r16 Ø7x24</p> 	<p>16x s2</p> 
<p>2x s1</p> 	<p>1x z1</p> 	<p>12x e1 Ø7x50</p> 	





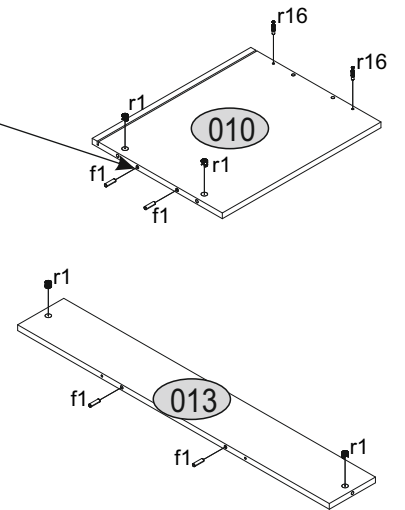
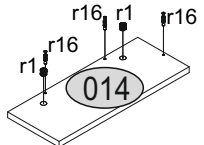
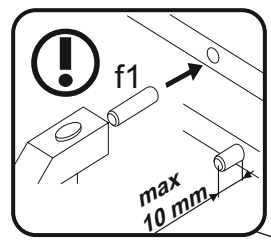
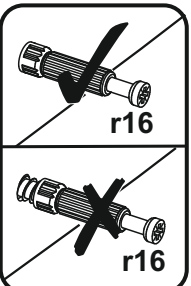
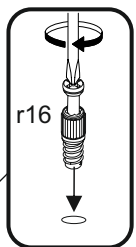
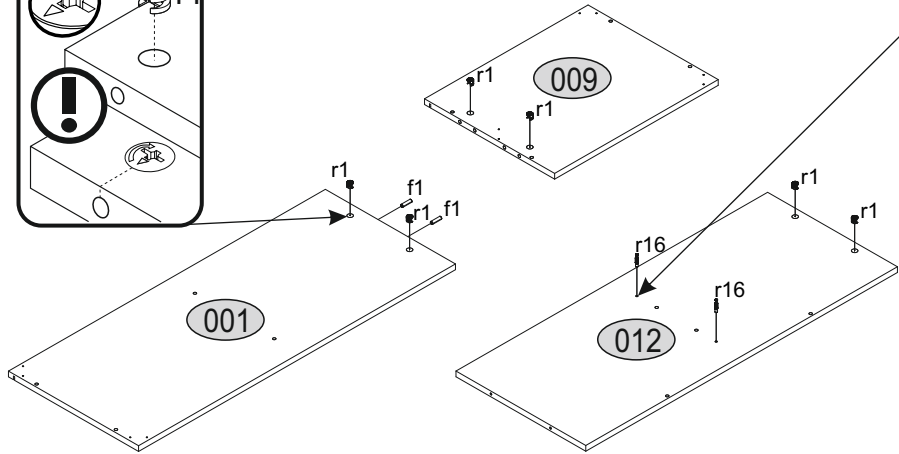
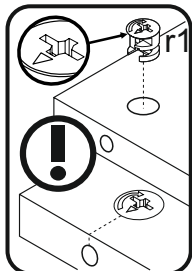

1

f1 	r1 	r16 
x6	x12	x7







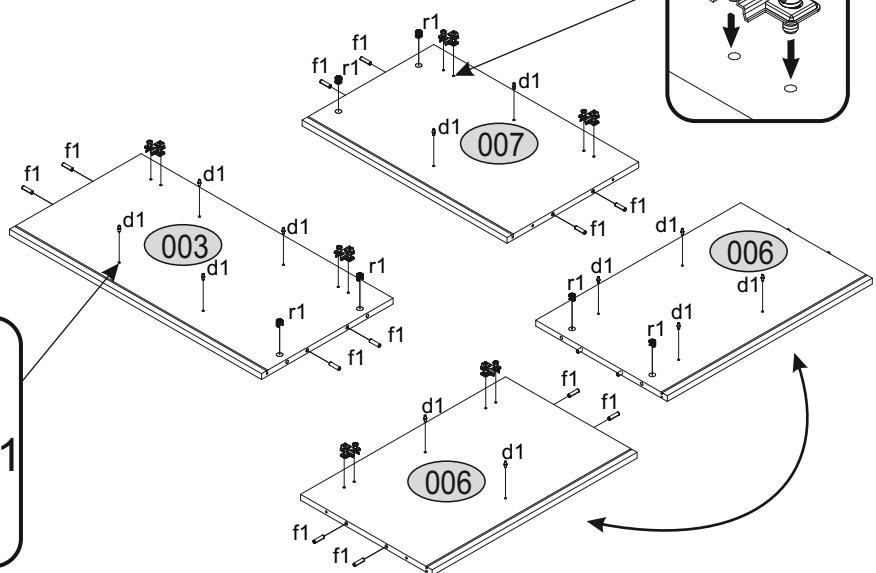
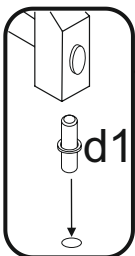
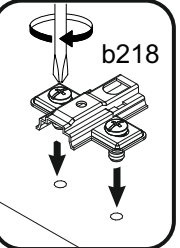

2

f1 	r1 	d1 	b218 
x12	x6	x12	x6



3

f1 	r1 	r16 	p25 	m30.01 	d1 
x4	x4	x3	x6	x3	x4

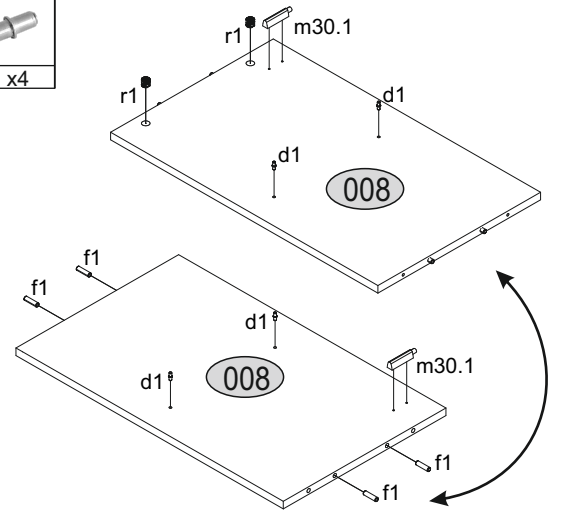
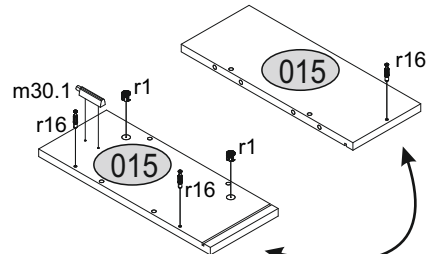
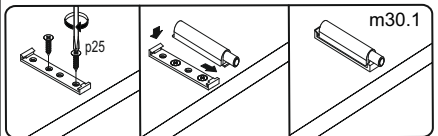

4

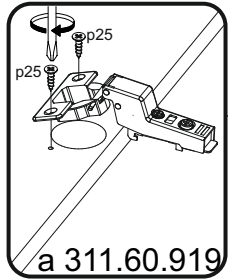
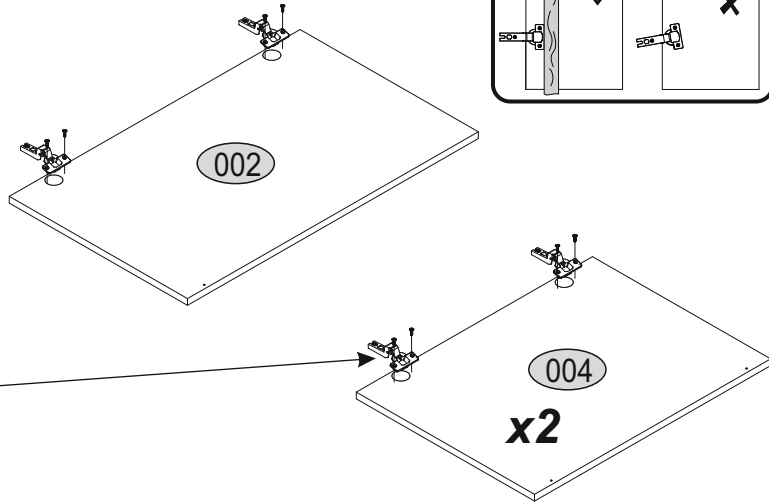
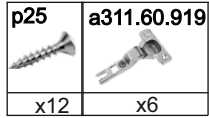

5

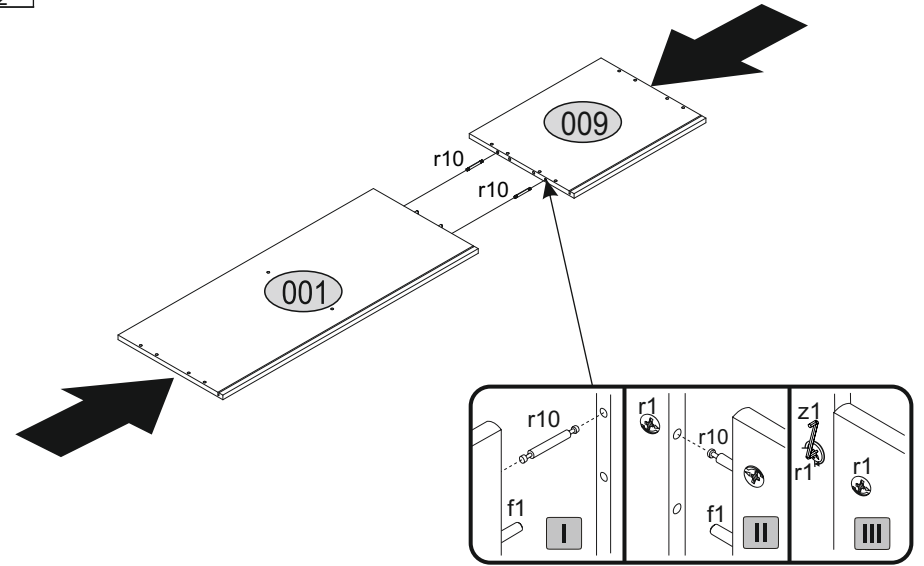
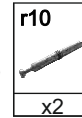

6

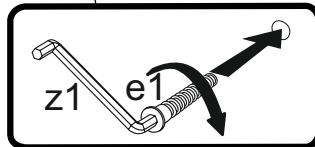
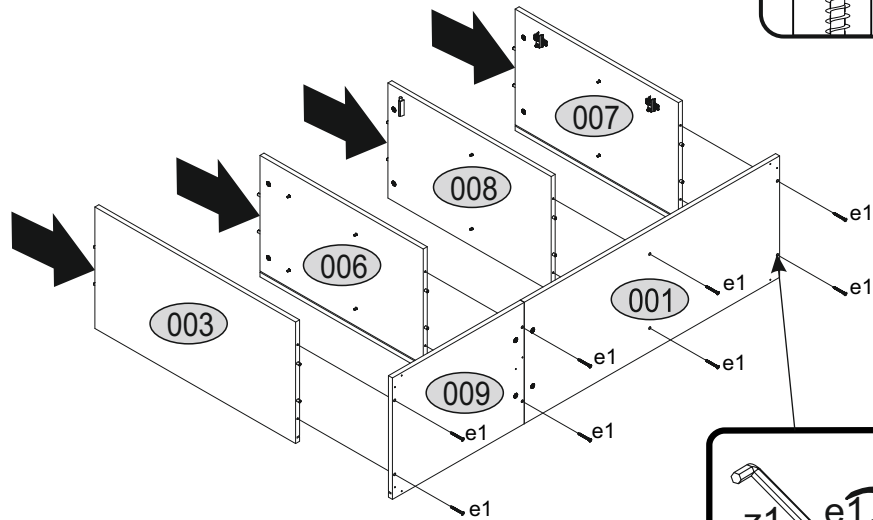
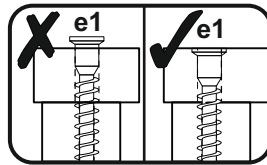
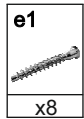

7

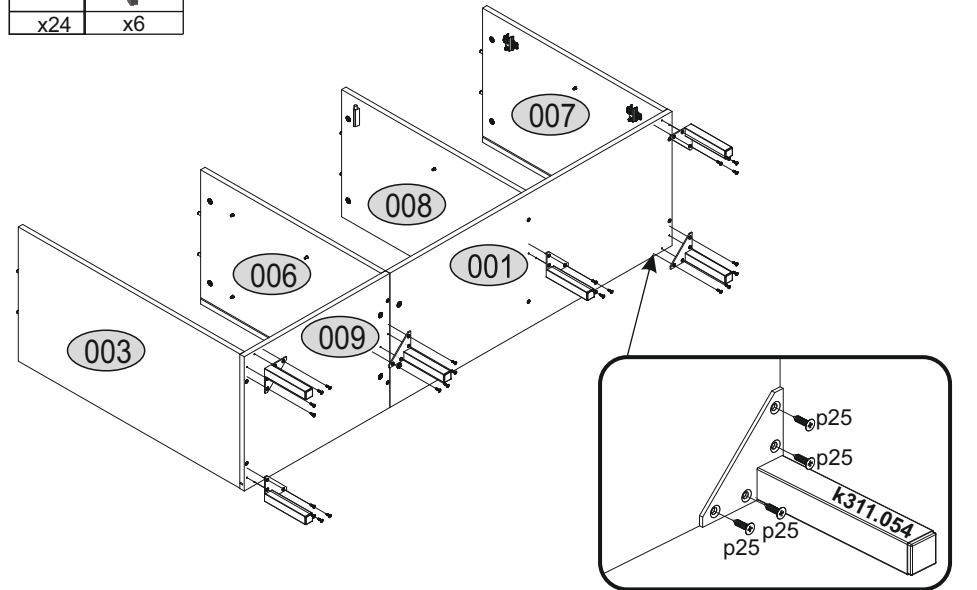
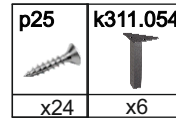

8

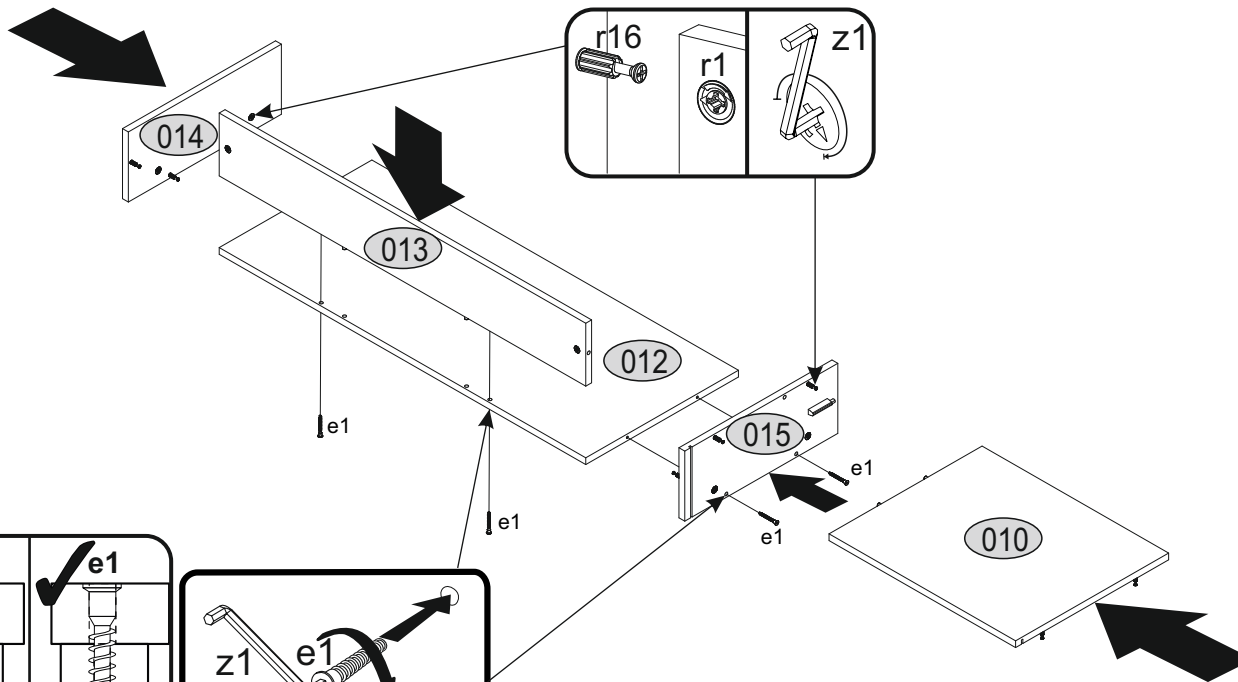
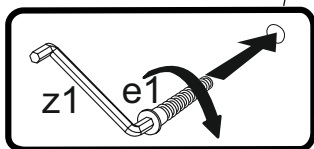
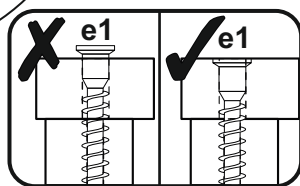
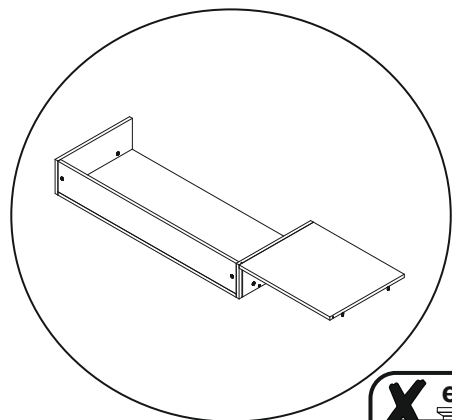

9

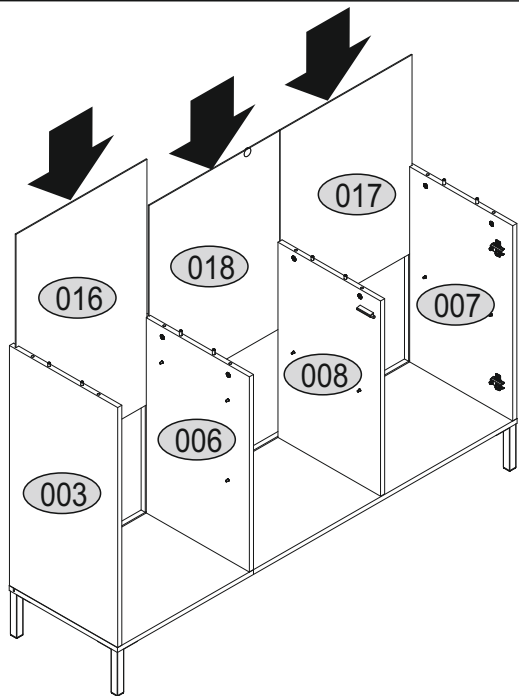

10

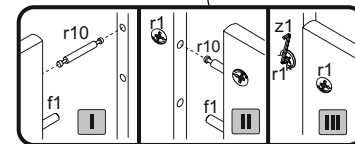
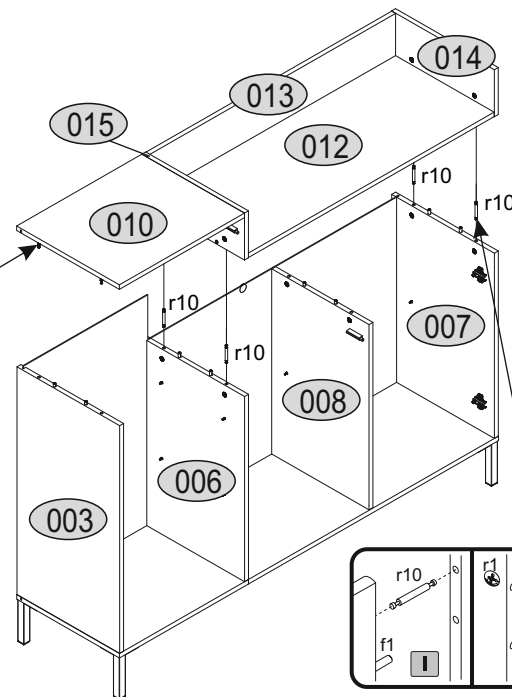
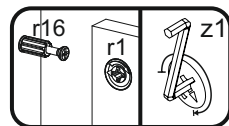
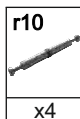

11

p17	p25	n14	n260.01	l2	f3
x1	x14	x1	x2	x10	x1

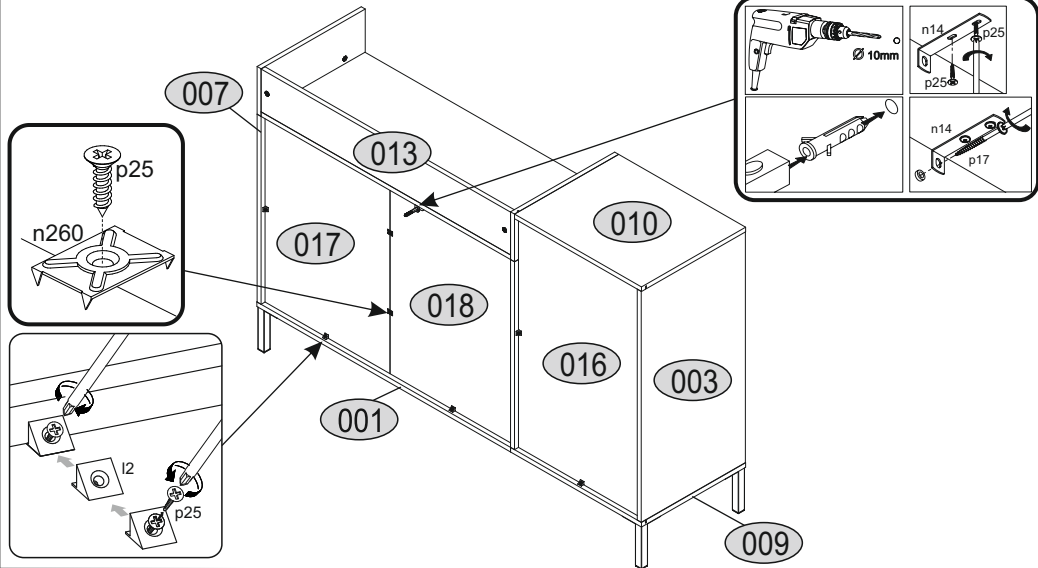

13

m30.1	s1	s2
x3	x2	x16

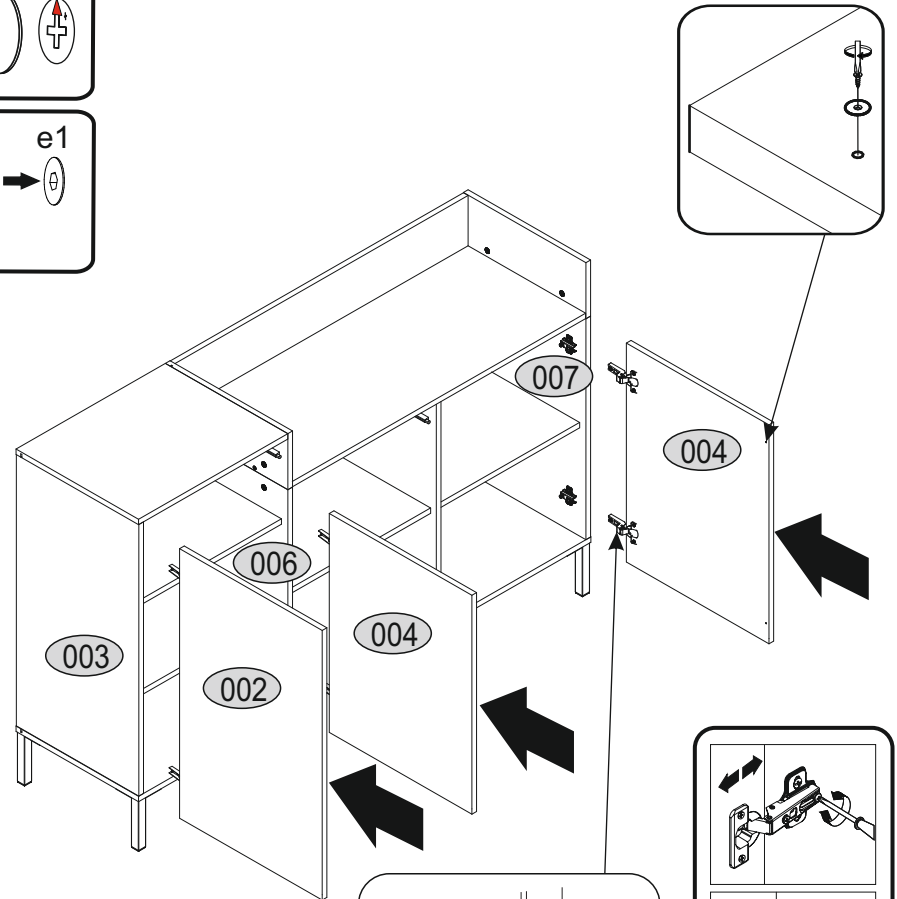
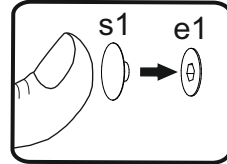
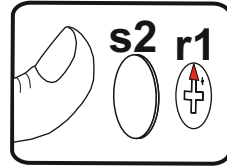

12

